

TRENDnet®

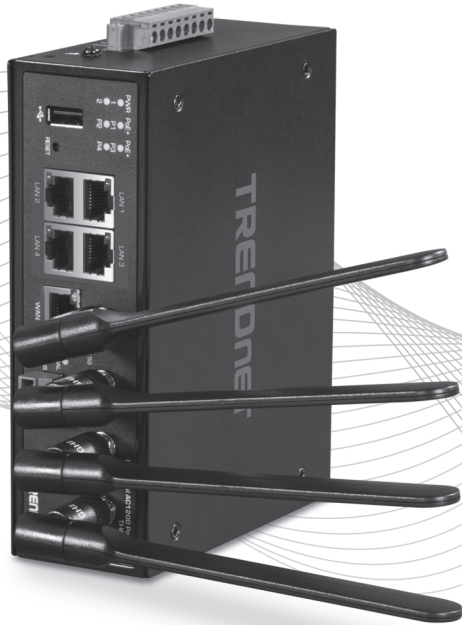

Quick Installation Guide TI-WP100 (V1.0R)

Table of Contents

1 English

1. Before You Start
2. Quick Reference
3. Hardware Installation
4. Applying Power
5. Hardware Configuration

1. Before You Start

Package Contents

- TI-WP100
- Quick Installation Guide
- 4 x detachable dual-band antennas
- Network cable (1.5m / 5 ft.)
- 1 x 8-pin removable terminal block (Power & digital input/output)
- 1 x 4-pin removable terminal block (Serial)
- DIN-Rail mounting bracket

Minimum Requirements

- Power supply [ex. model TI-S12048 (120W), TI-12024 (120W), TI-S24048 (240W)]
- A computer with a wired or wireless network adapter and web browser
- Broadband Internet
- Installed modem
- RJ-45 Network Cable

Optional Equipment

- 35 mm DIN-Rail
- 2 x TEW-LB101 Magnetic Dual Antenna Base RP-SMA Female with RP-SMA Male Extension Cable

Note: The maximum power consumption of the TI-WP100 router with no PoE load is 20W. The maximum PoE power budget supported by the router is 120W resulting in a 140W max. power requirement for the full PoE budget to be available. Please choose the power supply according to your PoE power budget requirement.

2. Quick Reference

Note: By default, the admin password used to login to the router configuration, wireless network name/SSID, and wireless encryption settings have been pre-configured for your convenience and can be located on the included preset wireless settings sticker or on the device label located on the back of the router. By default, the router web management configuration page can be accessed from LAN ports LAN1-4 using the default LAN IP address <http://192.168.10.1> and WAN default configuration is set to DHCP client for Internet connectivity. You can choose to quickly set up your router using the diagram below and use the pre-configured settings or refer to the next section for more detailed instructions on initial installation and configuration.

Preset Wireless Settings	
Wi-Fi Name/SSID (AC/N) TRENDnetWP100_5GHz_XXXX (N/B/G) TRENDnetWP100_2.4GHz_XXXX	
Wi-Fi Password XXXXXXXXXXXX	
Management Login http://192.168.10.1 username: admin password: XXXXXXX	

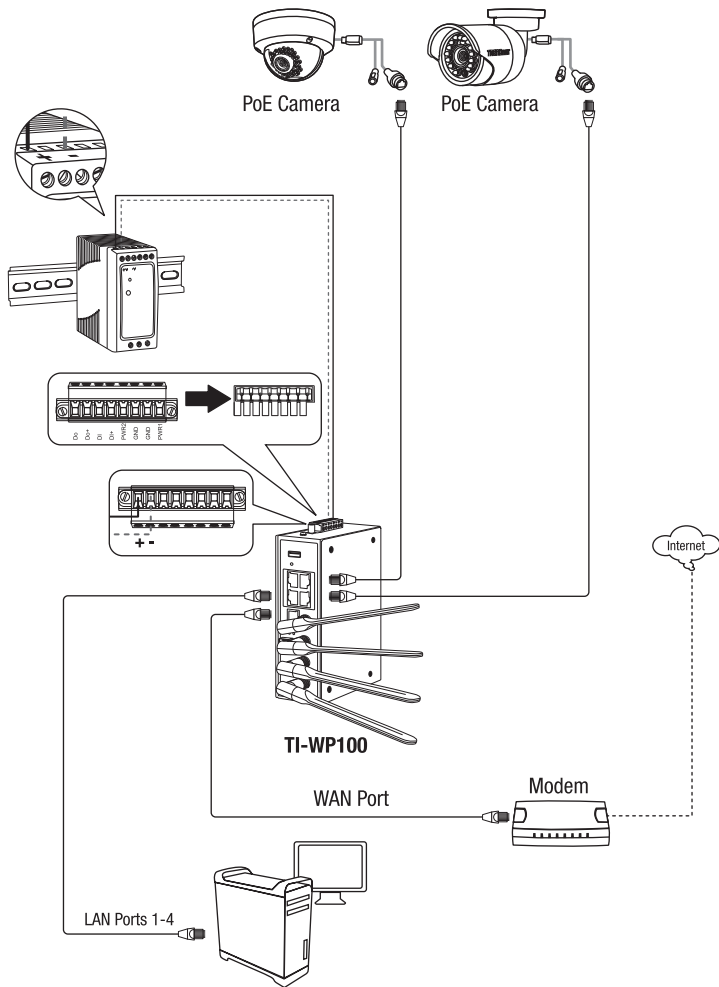

3. Hardware Installation

Note: The router can be placed on a desktop, wall, or mounted to a DIN-Rail.

DIN-rail Mounting Instructions

1. Attach the DIN-Rail mount to router.

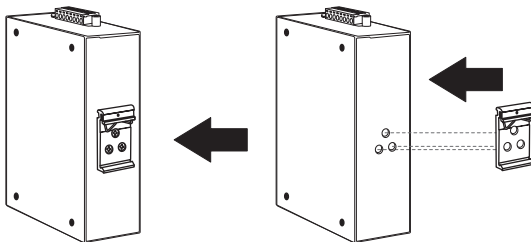

2. Position the unit in front of the DIN-Rail and hook the the mounting bracket over the top of the rail.
3. Rotate the router downward towards the rail to lock it into place.

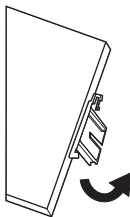

Mounting the unit

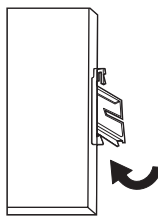

Releasing the unit

4. To remove the router, pull down to clear the bottom of the DIN-Rail and rotate away from the rail.

4. Applying Power

1. Connect the power supply [TI-S12048 (120W), TI-12024 (120W), TI-S24048 (240W) sold separately] to the included terminal block (as shown below) and secure with the screws.

Note: Polarities must match.

2. Attach the terminal block to the unit.

Optional: The router chassis can also be connected to a known grounding point for additional safety and protection (grounding wire is not included).

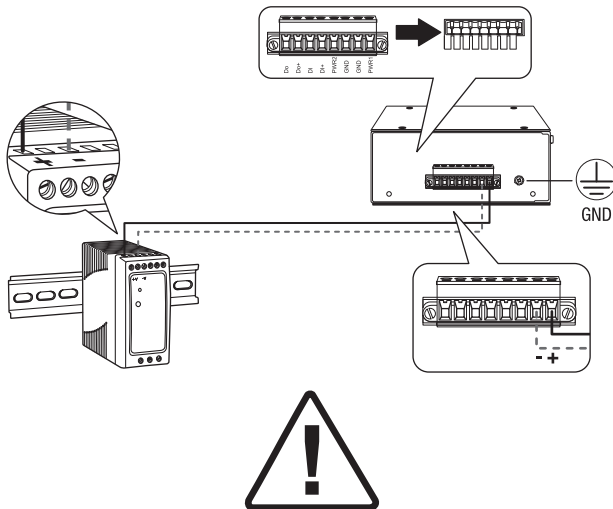

Safety Note

- Turn off the power before connecting any module or wire. The correct power supply voltage (24 – 56 V DC) is listed on the product label. Check the voltage of your power source to make sure that you are using the correct part. DO NOT use voltage greater than 24 – 56 V DC, as specified on the product label.
- Calculate the maximum possible current in each power wire and common wire. Observe all electrical codes dictating the maximum current allowable for each wire size. If the current surpasses the maximum ratings, the wiring could overheat, causing serious damage to your equipment.

5. Hardware Configuration

Note: It is recommended that you configure the wireless router from a wired computer.

1. Attach the antennas to the front of the router and position them for the best WiFi coverage. It is recommended that you position the antennas as shown.

Note: If mounting the router inside an industrial enclosure, you can also purchase two TEW-LB101 Magnetic Dual Antenna Base RP-SMA Female with RP-SMA Male Extension Cable (sold separately) for more optimal antenna placement outside of the enclosure.

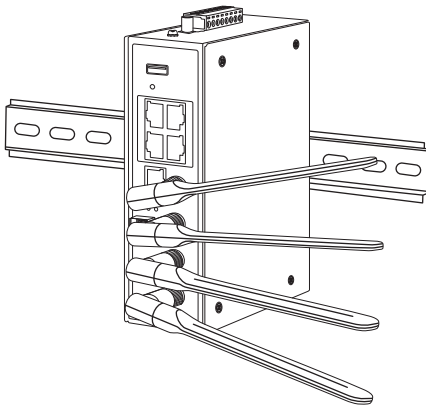

2. Connect an RJ-45 network cable from the WAN port of your router to your modem.

3. Connect an RJ-45 network cable from one of the LAN ports (LAN1-4) of your router to your computer.

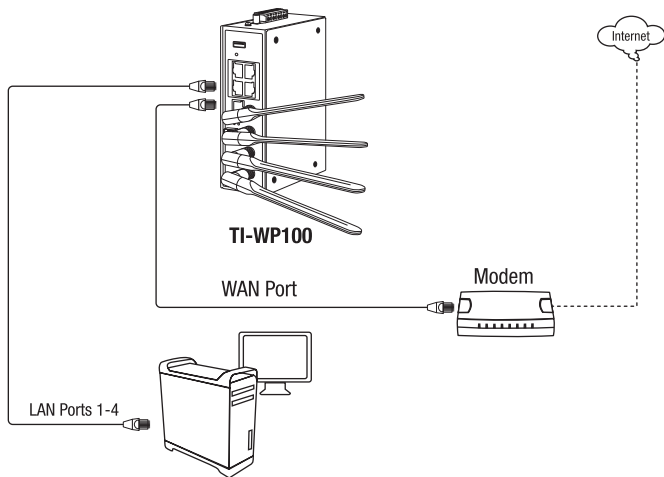

4. The PWR, 2.4G and WiFi 5G, Status LEDs will turn on solid indicating that the router is ready.

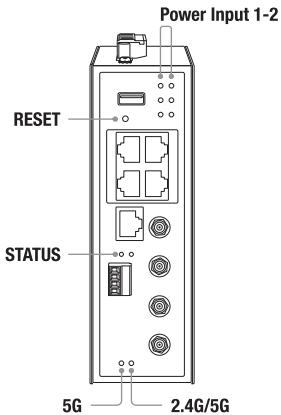

5. Open your web browser on the connected computer and in the address bar, enter `http://192.168.10.1` and press Enter to access the router web configuration page.

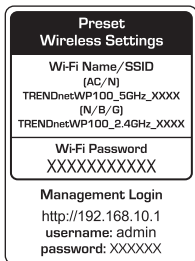

6. Enter the default **User Name** and **Password**, then click **Login**. By default, the pre-configured user name and password are located on the included preset wireless settings sticker or device label located on the back of the router.

A screenshot of the login page for a TRENDnet TI-WP100 router. The page has a dark background with white text. At the top, it says "TRENDnet TI-WP100 Login". Below that, there are two input fields: "Username" with "admin" entered and "Password" with "*****" entered. A "Login" button is located at the bottom right of the form.

7. To change the administrator password for the router configuration, click **Administration**, click **System Operation**, and click **Password & MMI**.

Note: By default, the administrator password has been pre-configured for your convenience and can be located on the included wireless settings sticker or on the device label located on the back of the router. If you are modifying the administrator password, you will need to login to the router configuration using the new password.

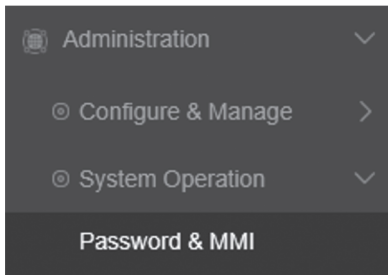

8. Enter the current administrator password in the **Old Password** field and enter the new password in the **New Password** and **Confirmation** fields, then click **Save** to apply the password configuration.



Password	
Old Password	<input type="text"/>
New Password	<input type="text"/>
New Password	<input type="text"/>
Confirmation	<input type="text"/>
<input type="button" value="Save"/> <input type="button" value="Undo"/>	

9. To change your router's LAN IP address settings, click on **Networking**, click on **LAN & VLAN**, and click on **Ethernet LAN**.

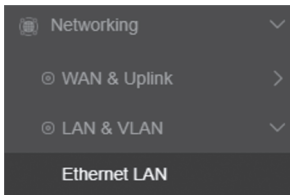

10. Enter the new LAN IP address in the **LAN IP Address** field and click the **Subnet Mask** drop-down list to select the subnet mask and click **Save** to apply the new LAN IP address settings. Please wait for the new address settings to be applied and log back into the router web configuration using the new LAN IP address.

Note: If your computer IP address are not automatically updated to the new settings, you may need to manually renew your computer IP address settings in order for you to log back into the router web configuration with the new LAN IP address settings.

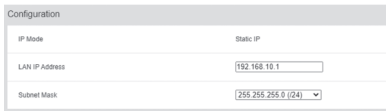

Configuration	
IP Mode	Static IP
LAN IP Address	<input type="text" value="192.168.10.1"/>
Subnet Mask	<input type="text" value="255.255.255.0 (24)"/>

11. To configure your WAN Internet connection settings, click **Networking**, click **WAN & Uplink**, and click **Connection Setup**.

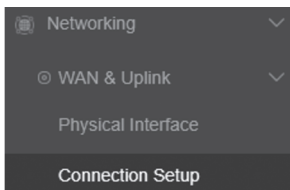

12. Under the **WAN-1** interface, under **Action**, click **Edit**.



13. Under the Internet Connection Configuration (WAN – 1), click the **WAN Type** drop-down list and select the appropriate protocol (**Static IP, Dynamic IP, PPPoE, PPTP, L2TP**) for your Internet connection. Dynamic IP (also known as DHCP client) is the typical protocol in which the connection settings are automatically obtained by your ISP (Internet Service Provider). If you are unsure about the Internet connection settings, please contact your ISP for details. After you have completed the Internet connection settings, click **Save** to apply the new WAN configuration settings.



14. To configure your wireless network name/SSID and wireless encryption settings, click **Networking**, click **WiFi**, and click the wireless module you would like to configure.

- **WiFi Module One** (By default, this module is set to operate at 2.4GHz)
- **WiFi Module Two** (This module only operates at 5GHz)

Note: By default, the wireless network name/SSID has been pre-configured for your convenience and can be located on the included wireless settings sticker or on the device label located on the back of the router. If you are modifying the wireless settings, you will need to connect to the router with your WiFi clients using the new wireless settings.

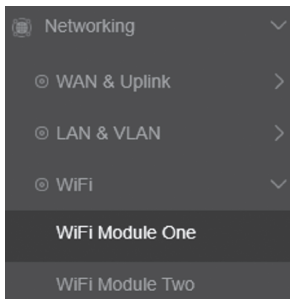

15. To change the wireless network name/SSID for the selected wireless module/band, under the 2.4GHz/5GHz VAP List at the bottom, for the default entry VAP1, under Actions, click **Edit**.

2.4G VAP List									Add	Delete
ID	ISP	SSID	Authn. Method	Encyption	Encryption	Beacon SFD	Enable	Admin		
1	WiFi 1	XXXXXXXXXX-XXXX-XXXX	WPA2PSK	AES	<input type="checkbox"/>	<input type="checkbox"/>	<input type="checkbox"/>	<input type="checkbox"/>	Edit	Delete
5.8G VAP List									Add	Delete
ID	ISP	SSID	Authn. Method	Encyption	Encryption	Beacon SFD	Enable	Admin		
1	WiFi 2	XXXXXXXXXX-XXXX-XXXX	WPA2PSK	AES	<input type="checkbox"/>	<input type="checkbox"/>	<input type="checkbox"/>	<input type="checkbox"/>	Edit	Delete

16. Enter the new wireless network name/SSID in the **SSID** field and enter the new wireless encryption key in the **Preshared Key** field, then click **Save**.

Note: The wireless network name/SSID is the name your WiFi clients will need to search and discover when connecting to your router wireless network. WPA2-PSK AES wireless encryption is strongly recommended. The wireless encryption key is the key our WiFi clients will need to enter when connecting to your router's wireless network.

2.4G VAP Configuration

VAP	VAP1 ▾
SSID	TRENDnetWP100_2.4GHz_XXXX
Max. STA	<input type="checkbox"/> Enable
Authentication	WPA2-PSK ▾
Encryption	AES ▾
Preshared Key	Wp20As2ccCjR
STA Isolation	<input type="checkbox"/>
Broadcast SSID	<input checked="" type="checkbox"/>
Enable	<input checked="" type="checkbox"/>

Save

17. After you have click Save, in the main wireless module/band page, click **Apply** at the bottom of the page to apply your wireless configuration settings.

Note: Please make sure to click Apply to save the wireless configuration settings. If Apply is not clicked, wireless configuration settings will not be saved to the router.

Save Undo Apply

Save to flash ONLY! Click on Apply button to take effect.

Note: To download the latest version of the user's guide, please go to <http://www.trendnet.com/support> and select the **TI-WP100** within the Product Download drop-down list.

Declaration of Conformity

TRENDNET®

Manufacturer's Name and Address

TRENDnet, Inc.
20675 Manhattan Place
Torrance, CA 90501 USA

Zwolsestraat 156 2587 WB
The Hague The Netherlands



Product Information:

Model Number: TI-WP100
Product Name: Industrial AC1200 Wireless Gigabit PoE+ Router
Trade Name: TRENDnet

TRENDnet hereby declare that the product is in compliance with the essential requirements and other relevant provisions under our sole responsibility.

Safety EN 62368-1:2014+A11:2017

EMC EN 55032:2015+AC:2016
EN 55024:2010+A1:2015
EN 55035:2017+A11:2020
EN 301 489-1 V2.1.1
EN 301 489-17 V3.1.1

Radio Spectrum & Health EN 300 328 V2.2.2
EN 301 893 V2.1.1
EN 50385:2002

This product is herewith confirmed to comply with the Directives.

Directives: EMC Directive 2014/30/EU
RoHS Directive 2011/65/EU
RoHS 3 Directive 2015/863/EU
WEEE Directive 2012/19/EU
REACH Regulation (EC) No. 1907/2006
Low Voltage Directive 2014/35/EU
Radio Equipment Directive 2014/53/EU

This device is designed to provide uninterrupted operation. This device does not offer power management functionality such as Off mode or Standby mode.

Person responsible for this declaration.

Place of Issue: Torrance, California, USA

Date: July 12, 2021

Name: Sonny Su

Title: VP of Technology

Signature:

A handwritten signature in black ink, appearing to read 'Sonny Su', is written over a horizontal line.



Declaration of Conformity

TRENDNET[®]

Manufacturer's Name and Address

TRENDnet, Inc.
20675 Manhattan Place
Torrance, CA 90501 USA

Authorized Representative:
Office: +44 (0) 1635 887 399
Unit 4 Rivermead Business Park,
Pipers Way, Thatcham, RG19 4EP England



Product Information:

Model Number: TI-WP100
Product Name: Industrial AC1200 Wireless Gigabit PoE+ Router
Trade Name: TRENDnet

TRENDnet hereby declare that the product is in compliance with the essential requirements and other relevant provisions under our sole responsibility.

Safety EN 62368-1:2014+A11:2017
EMC EN 55032:2015+AC:2016
EN 55024:2010+A1:2015
EN 55035:2017+A11:2020
EN 301 489-1 V2.1.1
EN 301 489-17 V3.1.1
Radio Spectrum & Health EN 300 328 V2.2.2
EN 301 893 V2.1.1
EN 50385:2002

This product is herewith confirmed to comply with the Directives.

Directives: Electromagnetic Compatibility Regulations 2016
The Restriction of the Use of Certain Hazardous Substances in Electrical and Electronic Equipment Regulations 2012
The Waste Electrical and Electronic Equipment Regulations 2013 (as amended)
The REACH Enforcement Regulations 2008 (as amended)
Electrical Equipment (Safety) Regulations 2016
Radio Equipment Regulations 2017

This device is designed to provide uninterrupted operation. This device does not offer power management functionality such as Off mode or Standby mode.

Person responsible for this declaration.

Place of Issue: Torrance, California, USA

Date: July 12, 2021

Name: Sonny Su

Title: VP of Technology

Signature:

A handwritten signature in black ink, appearing to read 'Sonny Su', is written over a horizontal line.



FCC Statement

This equipment has been tested and found to comply with the limits for a Class B digital device, pursuant to part 15 of the FCC Rules. These limits are designed to provide reasonable protection against harmful interference in a residential installation. This equipment generates, uses and can radiate radio frequency energy and, if not installed and used in accordance with the instructions, may cause harmful interference to radio communications. However, there is no guarantee that interference will not occur in a particular installation. If this equipment does cause harmful interference to radio or television reception, which can be determined by turning the equipment off and on, the user is encouraged to try to correct the interference by one or more of the following measures:

- Reorient or relocate the receiving antenna.
- Increase the separation between the equipment and receiver.
- Connect the equipment into an outlet on a circuit different from that to which the receiver is connected.
- Consult the dealer or an experienced radio/TV technician for help.

FCC Radiation Exposure Statement

This device complies with FCC radiation exposure limits set forth for an uncontrolled environment and it also complies with Part 15 of the FCC RF Rules. This equipment must be installed and operated in accordance with provided instructions and the antenna(s) used for this transmitter must be installed to provide a separation distance of at least 20 cm from all persons and must not be co-located or operating in conjunction with any other antenna or transmitter. End-users and installers must be provided with antenna installation instructions and consider removing the no-collocation statement.

This device complies with Part 15 of the FCC Rules. Operation is subject to the following two conditions:

- (1) this device may not cause harmful interference, and
- (2) this device must accept any interference received, including interference that may cause undesired operation.

Caution!

Any changes or modifications not expressly approved by the party responsible for compliance could void the user's authority to operate the equipment.

TRENDNET®

Certifications

This device complies with Part 15 of the FCC Rules. Operation is subject to the following two conditions:

- (1) This device may not cause harmful interference.
- (2) This device must accept any interference received. Including interference that may cause undesired operation.



Waste electrical and electronic products must not be disposed of with household waste. Please recycle where facilities exist. Check with your Local Authority or Retailer for recycling advice.

For EU/EFTA and UK(NI), this product can be used in the listed countries.



AL	AT	BA	BE	BG	CH	CY	CZ	DE	DK	ES	
FI	FR	GR	HR	HU	IE	IS	IT	LU	LV	ME	MK
MT	NL	NO	PL	PT	RO	RS	SE	SI	SK	UK(NI)	

This product may be operated in 2.4GHz and/or 5GHz bands, and is restricted to indoor use only when operating in 5.15-5.35GHz in the listed EU countries and UK(NI).

Please refer to the Warranty Guide for full details on restrictions.

(DE) Dieses Produkt kann mit dem 2.4-GHz und/oder 5-GHz-Band betrieben werden und ist in den genannten EU-Ländern und in GB(NI) nur zur Verwendung in Innenräumen bestimmt, wenn es mit 5.15-5.35 GHz betrieben wird.

(FR) Ce produit peut fonctionner dans les bandes 2.4 GHz et/ou 5 GHz, et est limité à une utilisation en intérieur uniquement lorsqu'il fonctionne dans les bandes 5.15-5.35 GHz dans les pays de l'UE et au Royaume-Uni (NI).

(ES) Este producto puede utilizarse en las bandas de 2.4 GHz y/o 5 GHz, y está restringido para su uso solo en interiores cuando se utiliza a 5.15-5.35 GHz en los países indicados de la UE y en el Reino Unido (NI).

(IT) Questo prodotto può essere utilizzato nelle bande 2.4GHz e/o 5GHz, ed è limitato all'uso interno solo quando funziona in 5.15-5.35GHz in UE e nel Regno Unito (NI).

(NL) Dit product kan worden gebruikt op 2.4GHz en/of 5GHz-banden en is beperkt tot enkel binnen gebruik wanneer gebruikt op 5.15-5.35GHz in de EU en het VK (NI).

(PL) Ten produkt może być używany wyłącznie w pasmach 2.4 GHz i/lub 5 GHz oraz tylko wewnątrz budynków podczas działania w paśmie 5.15-5.35 GHz w wymienionych krajach UE i Wielkiej Brytanii (NI).

(CZ) Tento výrobek lze provozovat v pásmech 2.4 GHz a/ nebo

5 GHz a v pásmu 5,15–5,35 GHz je omezen pouze na interní použití v uvedených zemích EU a Velké Británie (Severním Irskem).

(HU) A termék a 2.4 GHz-es és/vagy 5 GHz-es sávokban üzemeltethető, és a felsorolt EU-oroszágokban és az Egyesült Királyságban (Észak-Írországban) csak beltéren használható, ha az 5,15–5,35 GHz-es frekvencián működik.

(NO) Dette produktet kan brukes på båndene 2.4 GHz og/eller 5 GHz og er begrenset til innendørs drift ved bruk av 5.15-5.35 GHz i EU-landene på listen og i Storbritannia.

(DK) Dette produkt kan benyttes på frekvensområderne på 2.4GHz og/eller 5GHz og er kun til indendørs brug, når de bruges på 5.15-5.35GHz i de angivne EU-lande og Storbritannien (NI).

(FI) Tätä tuotetta voidaan käyttää 2.4 GHz:n ja/tai 5 GHz:n kaistoilla, ja se on rajoitettu ainoastaan sisäkäyttöön, kun sitä käytetään 5,15-5,35 GHz:n taajuuksilla luetteluissa EU-maissa ja Yhdistyneessä kuningaskunnassa (ja Pohjois-Irannissa).

(SE) Den här produkten kan användas frekvensbanden 2.4 GHz och/eller 5 GHz och är begränsad till endast inomhusanvändning när den används 5.15-5.35 GHz i de uppräpnade EU-länderna och UK (NI).

(PT) Este produto pode ser operado nas bandas de 2.4 GHz e/ou 5 GHz e é restrito para utilização em espaços interiores apenas quando opera na frequência de 5.15-5.35 GHz nos países listados da UE e no Reino Unido (NI).

(GR) Αυτό το προϊόν μπορεί να χρησιμοποιηθεί στις ζώνες συχνοτήτων 2.4GHz ή/και 5GHz και η χρήση επιτρέπεται μόνο σε εσωτερικούς χώρους όταν λειτουργεί στα 5,15-5,35GHz στις αναφερόμενες χώρες της ΕΕ και στο ΗΒ. (NI).

(HR) Ovak proizvod može raditi u frekvenzijskim pojascima od 2.4 GHz i/ili 5 GHz i njegova uporaba je ograničena na

zatvorene prostore samo kada radi u frekvenzijskom pojasu od 5,15 - 5,35 GHz u navedenim državama članicama EU-a i u Ujedinjenom kraljevstvu (Sjeverno Irskoj).

(SI) Ta izdelek lahko deluje v 2.4- in/ali 5-GHz pasu in je pri delovanju v pasu od 5,15 do 5,35 GHz v navedenih državah EU in v VB omejen samo na notranjo uporabo.

(RO) Acest produs poate fi operat în benzile de 2.4GHz și/au 5GHz, și este restricționat la utilizare în interior la funcționarea în 5.15-5.35GHz în țările din UE listate și în UK(NI).

(BG) Този продукт може да се използва в 2.4GHz и/или 5GHz честотни ленти и е ограничен до използване на закрито само когато работи в диапазона 5.15 – 5.35GHz в изброените страни от ЕС и Великобритания (Северна Ирландия).

(SK) Tento výrobok môže byť používaný v pásmach 2.4 GHz a/alebo 5 GHz a jeho používanie je obmedzené len na interiéry, ak sa používa v pásmach 5,15 až 5,35 GHz v uvedených krajinách EU a Spojenom kráľovstve a Severnom Irsku.

(IS) Þessi vöru má nota á tönnubílu 2.4 GHz og/eda tönnubílu 5 GHz, þó einungis innandyri við notkun á milli 5.15 - 5.35 GHz í löngindum ESB-landum og Bretlandi (NI).

(MT) Dan l-prodott jista' jilhadhom l-frekwenza ta' 2.4GHz u/jew 5GHz, u hawn ristrett għal użu għawt biss meta jilhadhom f'5.15-5.35GHz fil-pajjiżi elenkati tal-UE u tar-Reġju Unjani(NI).

This product can be used in the UK

 This product may be operated in 2.4GHz and/or 5GHz bands, and is restricted to indoor use only when operating in 5.15-5.35GHz in the UK. Please refer to the Warranty Guide for full details on restrictions.

Applies to PoE Products Only: This product is to be connected only to PoE networks without routing to the outside plant.

Note

The Manufacturer is not responsible for any radio or TV interference caused by unauthorized modifications to this equipment. Such modifications could void the user's authority to operate the equipment.

Advertencia

En todos nuestros equipos se mencionan claramente las características del adaptador de alimentación necesario para su funcionamiento. El uso de un adaptador distinto al mencionado puede producir daños físicos y/o daños al equipo conectado. El adaptador de alimentación debe operar con voltaje y frecuencia de la energía eléctrica domiciliar existente en el país o zona de instalación.

Technical Support

If you have any questions regarding the product installation, please contact our Technical Support.

Toll free US/Canada: **1-855-373-4741**

Regional phone numbers available

at www.trendnet.com/support

TRENDnet

20675 Manhattan Place
Torrance, CA 90501
USA

Product Warranty Registration

Please take a moment to register your product online. Go to TRENDnet's website at:

www.trendnet.com/register